



SIERRA VIDEO

## **SIERRA VIDEO**

---

Aspen 7272 HD/SDI 3G Routing Switcher

Models: 7272HD-3G

# User's Manual



**SIERRAVIDEO**



ASPEN 7272 HD/SDI 3G ROUTING SWITCHER

# User's Manual

---

© Sierra Video  
P.O. Box 2462 Grass Valley, CA 95945  
Tel: (530) 478-1000  
Fax: (530) 478-1105  
Email: [info@sierravideo.com](mailto:info@sierravideo.com)

Version 2.0  
Publication Date: September 2014

The information contained in this manual is subject to change by Sierra Video



# Regulatory Warnings & Safety Information

The information in the following section provides important warnings and safety guidelines for both the operator and service personnel. Specific warnings and cautions may be found throughout this manual. Please read and follow the important safety precautions noting especially those instructions relating to risk of fire, electrical shock and injury to persons.

Any instructions in this manual that require opening the equipment cover or enclosure are intended for use by qualified service personnel only. To reduce the risk of electrical shock, do not perform any servicing other than what is contained in the operating instructions unless you are qualified.



## **Warnings**

- Heed all warnings on the unit and in the operating instructions.
- Disconnect AC power before installing or removing device or servicing unit.
- Do not use this product in or near water.
- This product is grounded through the grounding conductor of the power cord. To avoid electrical shock, plug the power cord into a properly wired receptacle before connecting inputs or outputs.
- Route power cords and other cables so that they are not likely to be damaged, or create a hazard.
- Dangerous voltages exist at several points in this product. To avoid personal injury, do not touch unsafe connections and components when the power is on.
- Have qualified personnel perform safety checks after any completed service.
- To reduce risk of electrical shock, be certain to plug each power supply cord into a separate branch circuit employing a separate service ground.
- If equipped with redundant power, this unit has two power cords. To reduce the risk of electrical shock, disconnect both power cords before servicing.
- Operate only with covers and enclosure panels in place – Do Not operate this product when covers or enclosure panels are removed.
- This is an FCC class A product. In a domestic environment, this product may cause radio interference, in which case the user may be required to take necessary measures.



## **Cautions**

- Use the proper AC voltage to supply power to the switcher. When installing equipment, do not attach the power cord to building surfaces.

 **Cautions (continued)**

- Use only the recommended interconnect cables to connect the switcher to other frames.
- Follow static precautions at all times when handling the equipment.
- Power this product only as described in the installation section of this manual.
- Leave the sides of the frame clear for air convection cooling and to allow room for cabling. Slot and openings in the frame are provided for ventilation and should not be blocked.
- Only an authorized Sierra Video technician should service the switchers. Any user who makes changes or modifications to the unit without the expressed approval of Sierra Video will void the warranty.
- If installed in a closed or multi-unit rack assembly, the operating ambient temperature of the rack environment may be greater than the room ambient temperature. Therefore, consideration should be given to installing the equipment in an environment compatible with the manufacturer's maximum rated ambient temperature (TMRA).
- Installation of the equipment in a rack should be such that the amount of air flow required for safe operation of the equipment is not compromised.
- Other connections between peripherals of this equipment may be made with low voltage non-shielded computer data cables.
- Network connections may consist of non-shielded CAT 5 cable.
- Do not cover chassis ventilation slots or block enclosure openings.

**FCC Notice**

This equipment has been tested and found to comply with the limits for a Class A digital device, pursuant to Part 15 of the FCC rules. These limits are designed to provide reasonable protection against harmful interference when the equipment is operated in a commercial environment. This equipment generates, uses, and can radiate radio frequency energy and, if not installed and used in accordance with the instruction manual, may cause harmful interference to radio communications. Operation of this equipment in a residential area is likely to cause harmful interference in which case the user will be required to correct the interference at the expense of the user.

The user may find the following publication prepared by the Federal Communications Commission helpful:

"How to Identify and Resolve Radio-TV Interference Problems" (Stock number 004-000-00345-4). Available exclusively from the Superintendent of Documents, Government Printing Office, Washington, DC 20402 (telephone 202 512-1800).

**Warning**

Changes or modifications not expressly approved by the party responsible for compliance to Part 15 of the FCC Rules could void the user's authority to operate the equipment.

## ***Power Supply Cords***

Use only power cord(s) supplied with the unit.

If power cord(s) were not supplied with the unit, select as follows:

For units installed in the USA and Canada: select a flexible, three-conductor power cord that is UL listed and CSA certified, with individual conductor wire size of #18 AWG, and a maximum length of 4.5 meters. The power cord terminations should be NEMA Type 5-15P (three-prong earthing) at one end and IEC appliance inlet coupler at the other end. Any of the following types of power cords are acceptable; SV, SVE, SVO, SVT, SVTO, SVTOO, S, SE, SO, SOO, ST, STO, STOO, SJ, SJE, SJO, SJOO, SJT, SJTOO, SP-3, G, W.

For units installed in all other countries; select only a flexible, three-conductor power cord, approved by the cognizant safety organization of your country. The power cord must be Type HAR (Harmonized), with individual conductor wire size of 0.75 mm<sup>2</sup>. The power cord terminations should be a suitably rated earthing-type plug at one end and IEC appliance inlet coupler at the other end. Both of the power cord terminations must carry the certification label (mark) of the cognizant safety organization of your country.

A non-shielded power cord may be used to connect AC power to every component and peripheral of the system.

Connect an external 16 AWG or larger wire from earth ground to the chassis of the system as designated by the earth ground symbol.

## **North American Power Supply Cords**

This equipment is supplied with North American power cords with molded grounded plug (NEMA-15P) at one end and molded grounding connector (IEC 320-C13) at the other end. Conductors are CEE color coded, light blue(neutral), brown(line), and green/yellow(ground). Operation of the equipment at voltages exceeding 130VAC will require power supply cords that comply with NEMA configurations.

## **International Power Supply Cords**

If shipped outside North America, this equipment is supplied with molded ground connector (IEC 320-C13) at one end and stripped connectors (50/5mm) at the other end. Connections are CEE color coded, light blue (neutral), brown(line), and green/yellow(ground). Other IEC 320-C13 type power cords can be used if they comply with safety regulations of the country in which they are installed.

## ***EMC Regulatory Notices***

Federal Communications Commission (FCC) Part 15 Information: This device complies with Part 15 of the FCC standard rules. Operation is subject to the following conditions:

This device may not cause harmful interference

This device must accept any interference received including interference that may cause undesirable operations.

## ***Delivery Damage Inspection***

Carefully inspect the frame and exterior components to be sure that there has been no shipping damage.





# Table of Contents



Overview	1	Operation	31
Aspen 7272 HD/SDI 3G	1	Introduction	31
Introduction	1	Web Page	31
Model Suffix Designations	1	Button Colors	31
Model 7272 HD-3G	2	Switching the Routing switcher	32
		V and A Buttons	32
Installation	3	Destination based Switching	32
Introduction	3	Break-away Switching	32
Rack Mounting	3	Destination based Status	32
Dimensions	3	Source based Switching	33
Connecting To Video Devices	4	Source based Status	33
Connecting Peripherals	4	Salvo	33
Reference Connector	5	Control via 9-pin Connectors	34
AC Power Connections	5	Control via Ethernet	34
Configuration	7	HOST Protocol	35
Ethernet Setup	7	Introduction	35
Change Network Parameters	9	Command Summary	37
Change Serial Port Settings	10	Commonly Used Switching Commands	42
Mode	10		
Names	11	Troubleshooting	43
Salvos	12	Front Panel Error Indications	43
Overview	12	Power and Indicators	44
Salvo Setup	12	Video Signal	45
Advanced	13	Control	46
System Information	13	Switching Malfunctions	46
Inputs	14	Technical Support	46
Input Equalizers	14		
Output Reclockers	16	Specifications	47
Reference Settings	18		
Reference Formats	19	Warranty	49
Layers	20		
Multi-Frame Systems	21		
Dual Link Mode	22		
GUI Panel	24		
Alerts	26		
Changing Password	27		
Software Updates	28		
Factory Defaults	29		



# Overview

## Aspen 7272 HD/SDI 3G

### Introduction

The Sierra Video Aspen 7272 HD-3G routing switchers are compact units offering digital video boards that work with SDI video SMPTE 259M-C, HD SMPTE 292M, and 3G SMPTE 424M. These unique routing switchers can also route DVB-ASI signals.

Remote control is available using an RS-232/422 serial interface or an Ethernet port.

This manual covers the Aspen 7272 HD/SDI routing switcher. The 7272 HD/SDI system accommodates, audio follow video (AFV), or breakaway (split) routing.

### Model Suffix Designations

Model Suffix Designations	
7272	Routing Switcher size
HD	Multi-format HD/SDI Digital Video

# Model 7272 HD-3G

Frame Front Panel

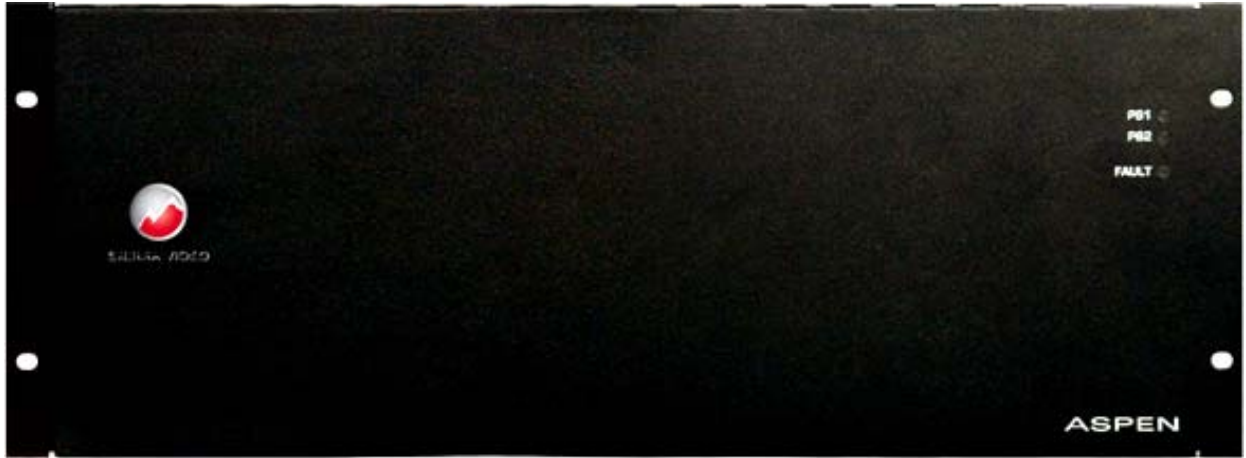

Frame Back Panel



Side



# Installation

## Introduction

Installation procedures are similar for all frames covered under this manual. Exceptions, if any, have been noted in each of the following paragraphs.

## Rack Mounting

Carefully inspect the frame to ensure that there has been no shipping damage. Make sure all shipping material is removed from the routing switcher frame.

The routing switcher described in this manual can be rack mounted in a standard 19" (RU) EIA rack assembly and includes rack "ears" at the ends of the front of the frames. It does not require spacing above or below the unit for ventilation.

To rack mount any of the routing switchers, simply place the unit's rack ears against the rack rails of the rack, and insert proper rack screws through each of the holes in the rack ears. Always rack mount the routing switcher prior to plugging the unit into a power receptacle or attaching any cables.

---

**CAUTION!**

*The operating temperature range of this product is 0 to 40°C. Do not exceed the maximum (40°C) or minimum (0°C) operating temperature.*

*If installed in a closed or multi-rack assembly, the operating ambient temperature of the rack environment may be greater than the room ambient temperature. Therefore, consideration should be given to installing the equipment in an environment compatible with the manufacturer's maximum rated ambient temperature.*

*Installation of the equipment in a rack should be such that the amount of air flow to the sides of the routing switcher required for safe operation of the equipment is not compromised.*

## Dimensions

Aspen 7272 Series HD-3G Routing switcher frame is 4 rack units high, 19" wide, and 2.5" deep.

## Connecting To Video Devices

Video sources and output devices (such as monitors, or recorders) may be connected to the routing switchers through the BNC type connectors located on the back of the unit. Keep in mind that the output signal format will be that of the input signal format.

To ensure the highest quality of video routing and switching, special attention should be observed to cables and connectors.

## Connecting Peripherals

Control panels, video reference inputs, and power are all connected to the rear of the frame. The peripherals area may vary depending on the model size and type.

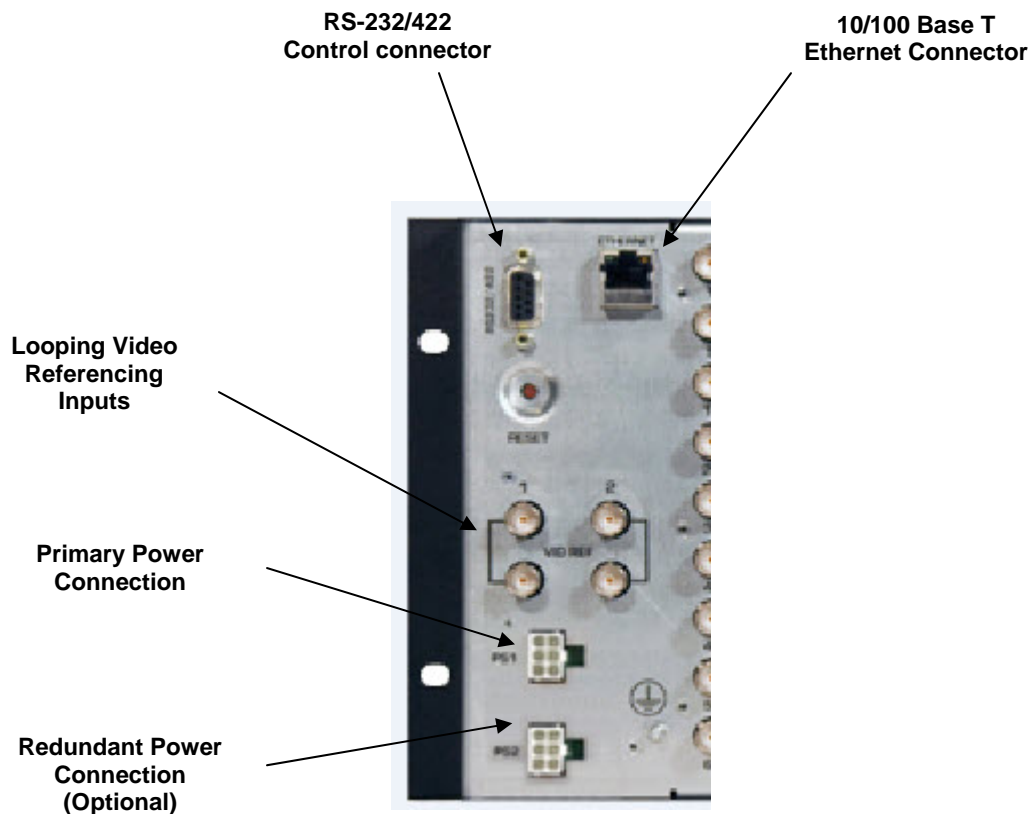

## Reference Connector

There are 4 BNC connectors labeled "VID REF1" and "VID REF 2". These are "looping" inputs for SMPTE analog video referencing. Connect composite, or tri-level sync to either BNC. If desired, use the second BNC to loop the signal to another device. If the loop is not used, terminate the second BNC with 75 ohms.

If a video reference signal is connected and the router is configured to use redundant references, the routing switcher, will cause all switching to occur during the vertical interval of the reference per SMPTE RP-168 and the supported video format standards shown on page 19. If no reference signal is available or the router is configured for "no references", the routing switcher will switch at a random point rather than during the vertical interval of the reference signal.

## AC Power Connections

Aspen routing switchers offer optional redundant power supplies. The redundant power supply must be ordered separately. The power supplies have universal AC inputs 100VAC- 240VAC. Voltage selection is not necessary because the power supply senses the correct AC input automatically.

The primary and optional redundant power supplies are external AC to DC converters.

Connect an external 16 AWG or larger wire from earth ground to the chassis of the system as designated by the earth ground symbol.

---

### **CAUTION!**

---

*Only an authorized Sierra Video technician can service the switchers. Any user who makes changes or modifications to the unit without the expressed approval of the manufacturer will void the warranty*

*Use the proper AC voltage to supply power to the switcher.*

*Use only the factory provided AC-DC desktop power supply to supply power to the switcher.*

*Use only the recommended interconnect cables to connect the switcher to other frames.*





# Configuration

## Ethernet Setup

Default IP settings;

IP Address- 192.168.1.200

Subnet mask- 255.255.255.0

Gateway IP Address- 0.0.0.0

To configure the IP port, the routing switcher must first be connected to your PC. This can be done by connecting cable to your PC and the routing switcher directly, or the routing switcher may be added to your existing network. The routing switcher defaults to an IP address of 192.168.1.200 which will not conflict with other devices in most systems. If there is an IP address conflict, direct connection must be used to configure the routing switchers Ethernet port. Once your PC and the routing switcher are on the same Ethernet network, open your internet browser and type in the default address of the routing switcher in the address line of the internet browser.

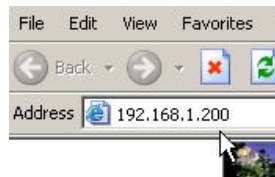

This will open a web page generated by the routing switcher. Routing switcher information is displayed on this page.

A screenshot of the Sierra Video ASPEN 7272HD-3G web interface. The page has a black header with the Sierra Video logo and the model name "ASPEN 7272HD-3G". Below the header are three tabs: "Operate", "About", and "Login". The "About" tab is selected. The main content area displays system information in a table format:

Model: ASPEN 7272HD-3G	Name: ASPEN 7272HD-3G	Power Supply 1: Present
Software Version: 1.03.02	IP Address: 192.168.6.93	Power Supply 2: Missing
Number of Inputs: 72	Subnet Mask: 255.255.255.0	Fan Status: Error
Number of Outputs: 72		Temperature Status: Ok

At the bottom of the page is a "Refresh" button.

---

**Note:**

---

The “Operate” tab is discussed in Chapter 4 “Operation”.

You must login to set or modify Routing switcher parameters. To login, select the login button.

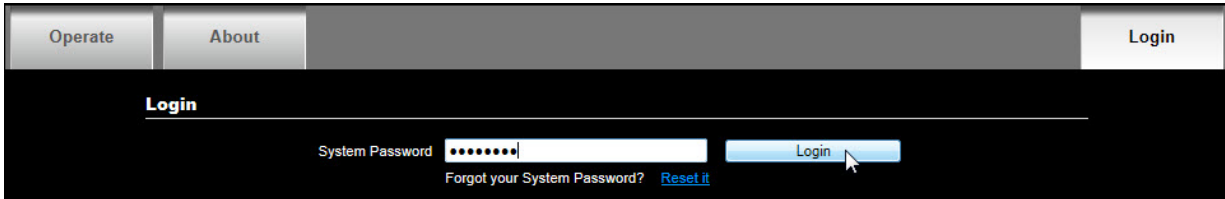

Enter the password and select “Login”.

---

**Note:**

---

The factory default password is “password”. To change the password see the section “Changing Password” at the end of this chapter.

After a successful login, you will be provided with additional tabs as shown below.

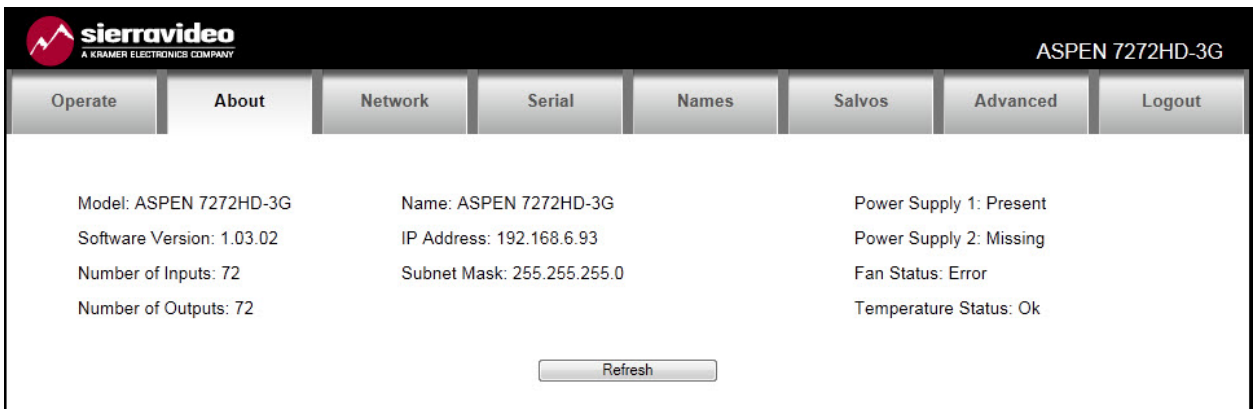

The “refresh” button will re-read the current settings in the routing switcher.

## Change Network Parameters

To make changes to the network communications (i.e. IP address), select the “Network” tab.

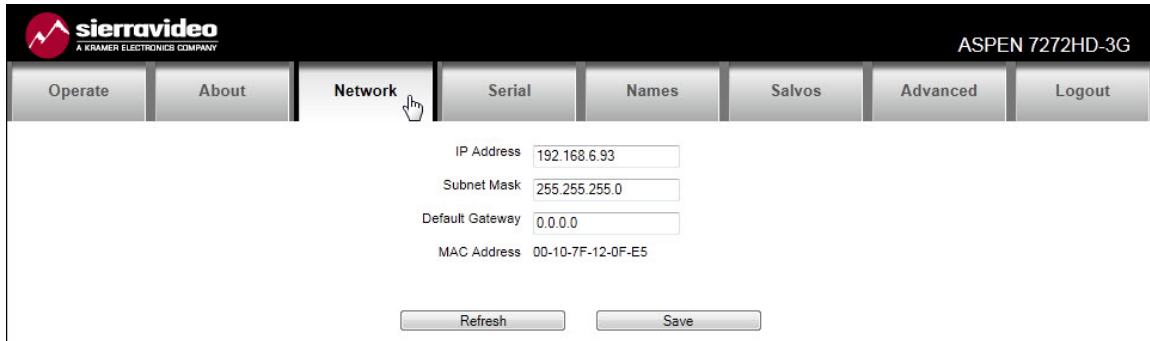

The screenshot shows the web interface for the ASPEN 7272HD-3G routing switcher. The top navigation bar includes the Sierravideo logo (A KRAMER ELECTRONICS COMPANY) on the left and the device model name 'ASPEN 7272HD-3G' on the right. Below the logo is a menu with tabs: Operate, About, Network (selected), Serial, Names, Salvos, Advanced, and Logout. The main content area displays network configuration parameters: IP Address (192.168.6.93), Subnet Mask (255.255.255.0), Default Gateway (0.0.0.0), and MAC Address (00-10-7F-12-0F-E5). At the bottom of the form are two buttons: Refresh and Save.

The “refresh” button will re-read the current settings in the routing switcher.

Make any changes necessary and press “Save” to implement changes.

---

**Note:**

*Changing any parameters in this window will cause your browser to lose communication with the routing switcher. You must enter the new IP address in your browser to re-establish communications.*

*Routing switcher need not be reset for changes to take effect.*

*DHCP is not supported.*

## Change Serial Port Settings

To make changes to the serial port settings (i.e. Baud Rate), select the “Serial” tab.

The screenshot shows a web interface with a navigation bar at the top containing tabs: Operate, About, Network, Serial (selected), Names, Salvos, Advanced, and Logout. Below the tabs, the Serial Port Settings are displayed. The settings are as follows:

- Serial Line: RS-232
- Baud Rate: 9600
- Flow Control: None
- Data Bits: 8
- Stop Bits: 1
- Parity: None
- Mode:
  - Master (controls external layers)
  - Slave (controlled by external devices)
- Protocol: Sierra Video Host
- Respond: Always

At the bottom of the settings area, there are two buttons: Refresh and Save.

The “refresh” button will re-read the current settings in the routing switcher.

Make any changes necessary and press “Save” to implement changes.

---

### Note:

*Routing switcher must be reset for changes to take effect. You will be prompted to reset the routing switcher. If you do not reset the routing switcher at this time you must remember to do so later by removing and re-applying the power.*

**\*When controlling an external routing switcher via the 9-pin serial connection, a “null modem” cable will probably be required. Check the pin-out on both devices to verify the cable needed.**

### Mode

The serial port has two mode settings, “Master” and “Slave”. In the “Master” mode the serial port is used to control external devices (layers). In the “Slave” mode the routing switcher can be controlled via the serial port by an external device (i.e. automation) and set to respond to either Sierra Video or Kramer 2000 protocol.

Mode

- Master (controls external layers)
- Slave (controlled by external devices)

Protocol: Sierra Video Host

Respond: Always

## Names

To change names of the routing switcher, any of the sources, destinations, or layers, select the “Names” tab.

Click on the cell you want to change and type in a new name.

The screenshot shows the 'Names' configuration page. At the top, there are navigation tabs: Operate, About, Network, Serial, **Names**, Salvos, Advanced, and Logout. Below the tabs, the 'Routing Switcher' field contains the text 'ASPEN 7272HD-3G'. To the right, there are three tables:

Sources	
Number	Name
1	Src 1
2	Src 2
3	Src 3
4	Src 4
5	Src 5
6	Src 6
7	Src 7
8	Src 8
9	Src 9
10	Src 10
11	Src 11
12	Src 12
13	Src 13
14	Src 14
15	Src 15
16	Src 16
17	Src 17
18	Src 18

Destinations	
Number	Name
1	Dst 1
2	Dst 2
3	Dst 3
4	Dst 4
5	Dst 5
6	Dst 6
7	Dst 7
8	Dst 8
9	Dst 9
10	Dst 10
11	Dst 11
12	Dst 12
13	Dst 13
14	Dst 14
15	Dst 15
16	Dst 16
17	Dst 17
18	Dst 18

Levels	
Number	Name
1	Lvl 1
2	Lvl 2

At the bottom of the interface, there are two buttons: 'Refresh' and 'Save'.

Make any changes necessary and press “Save” to implement changes.

---

**Note:**

*The routing switcher’s name is limited to 20 characters, other names are limited to 8 characters.*

## Salvos

### Overview

A Salvo is a list of crosspoint switches that are saved in the routing switcher and switched by a single “Salvo Take” command or from a salvo button on the front panel.

Up to 72 Salvos are stored in the routing switcher.

To make and name salvos, select the “Salvo” tab.

### Salvo Setup

To program a salvo, select a salvo number from the dropdown list. This number is the input button number, on the front panel, where the salvo will be stored and fired.

Enter a name (not required).

Enter the desired Input/Output combinations.

Select an “Action” (“Take” switches the selected level and “Take All” switches all levels).

Click on the “Add Above” or “Add Below” button (“Add Above will put the entry one step above the highlighted step and “Add Below will put the entry one step below the highlighted step).

Salvo has a maximum of 72 steps/actions.

The “refresh” button will re-read the current salvo in the routing switcher.

Make any changes necessary and press “Save Salvo” to program the Salvo.

## Advanced

The “Advanced” tab allows access to “engineering” settings such as input EQ, output reclockers, routing switcher expansion, etc.

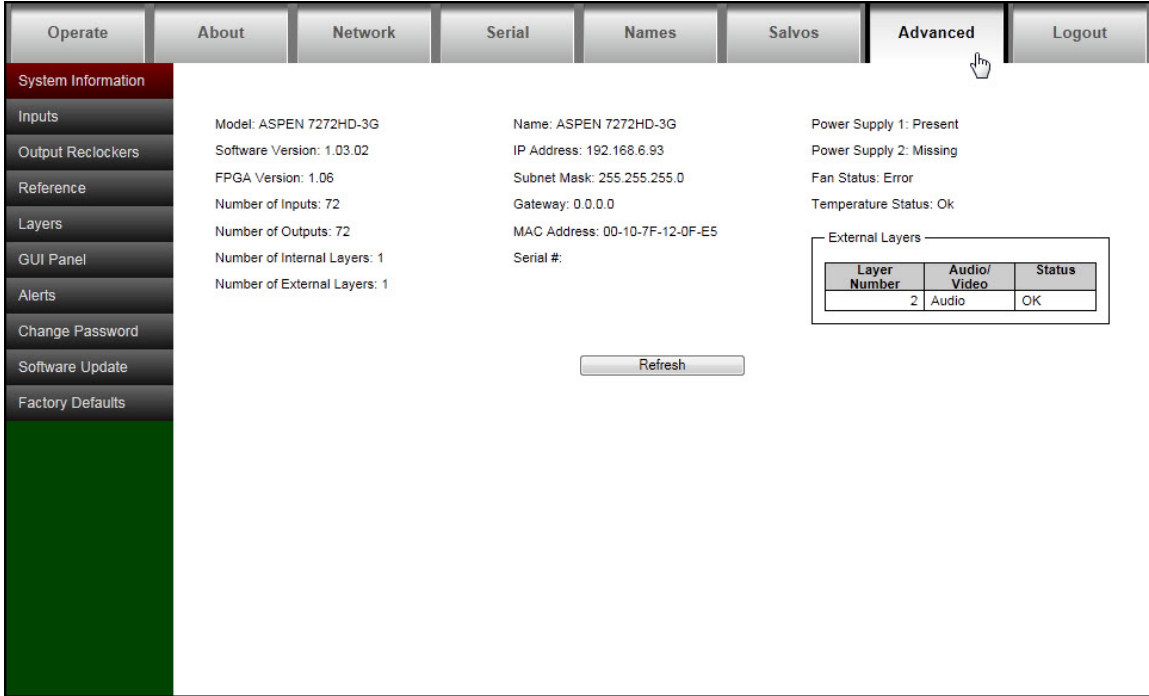

Clicking on the bars on the lefthand side of the screen gives access to adjustments and status.

## System Information

The “System Information” tab provides an overview of the system status and current configuration settings of the routing switcher.

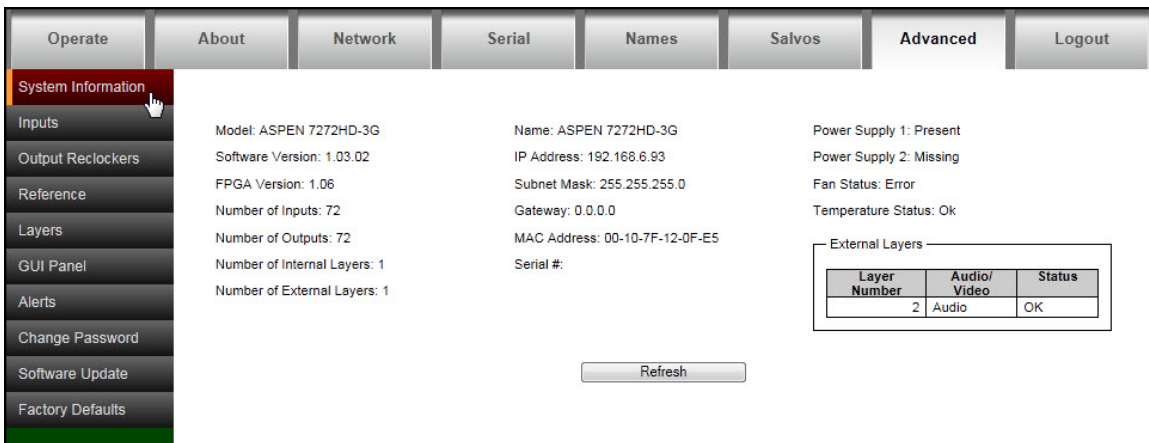

## Inputs

Select “Inputs” for access to cable equalizer adjustments and input signal status.

The screenshot shows a web interface with a top navigation bar containing tabs: Operate, About, Network, Serial, Names, Salvos, Advanced, and Logout. On the left, a sidebar menu has 'Inputs' highlighted. The main content area features a table with the following columns: Input, Source Name, Equalizer Mode, Input Presence, and Rate. The table lists 26 inputs. To the right of the table, there is a control panel with an 'Input' text box, an 'Equalizer Mode' dropdown menu (set to 'On'), and two buttons: 'Apply to Input' and 'Apply to All Inputs'. A 'Refresh' button is located below the table.

Input	Source Name	Equalizer Mode	Input Presence	Rate
1	Src 1	On	Missing	Unknown
2	Src 2	On	Missing	Unknown
3	Src 3	On	Missing	Unknown
4	Src 4	On	Missing	Unknown
5	Src 5	On	Missing	Unknown
6	Src 6	On	Missing	Unknown
7	Src 7	On	Missing	Unknown
8	Src 8	On	Missing	Unknown
9	Src 9	On	Present	SD
10	Src 10	On	Missing	Unknown
11	Src 11	On	Missing	Unknown
12	Src 12	On	Missing	Unknown
13	Src 13	On	Missing	Unknown
14	Src 14	On	Missing	Unknown
15	Src 15	On	Missing	Unknown
16	Src 16	On	Missing	Unknown
17	Src 17	On	Missing	Unknown
18	Src 18	On	Missing	Unknown
19	Src 19	On	Present	SD
20	Src 20	On	Present	SD
21	Src 21	On	Present	SD
22	Src 22	On	Missing	Unknown
23	Src 23	On	Missing	Unknown
24	Src 24	On	Missing	Unknown
25	Src 25	On	Missing	Unknown
26	Src 26	On	Missing	Unknown

This screen will status input signal presence and signal type.

Input	Source Name	Equalizer Mode	Input Presence	Rate
1	Src 1	On	Missing	Unknown
2	Src 2	On	Missing	Unknown
3	Src 3	On	Missing	Unknown
4	Src 4	On	Missing	Unknown

## Input Equalizers

To set or change a single input equalizer, enter the input number, select the equalizer mode from the drop down menu and press “Apply to Input”.

To set or change all input equalizers, select the equalizer mode and press “Apply to All Inputs”.

This close-up shows the control panel for a single input. The 'Input' text box contains the number '1'. The 'Equalizer Mode' dropdown menu is open, showing three options: 'On' (highlighted in blue), 'On', and 'Bypass'. Below the dropdown are two buttons: 'Apply to Input' and 'Apply to All Inputs'.

The factory recommended mode is “ON”



Input	Source Name	Equalizer Mode	Input Presence	Rate
1	Src 1	On	Missing	Unknown
2	Src 2	On	Missing	Unknown
3	Src 3	On	Missing	Unknown
4	Src 4	On	Missing	Unknown

If a valid input signal is detected, it will be indicated as “Present”.

The “Rate” column indicates the signal type detected at the input.

If the input is missing, the rate will be “Unknown”.

---

**Note:**

*If the signals you are connecting to the Aspen routing switcher inputs have a bit rate < 125Mbps, you may want to set the Equalizer mode to Bypass if you find you have bit errors in the video. This should not be a requirement for most low bit-rate signals.*

---

**Warning!**

*Changes to this screen could effect operation of the routing switcher.*

## Output Reclockers

Select “Output Reclockers” for access to reclocker adjustments and status.

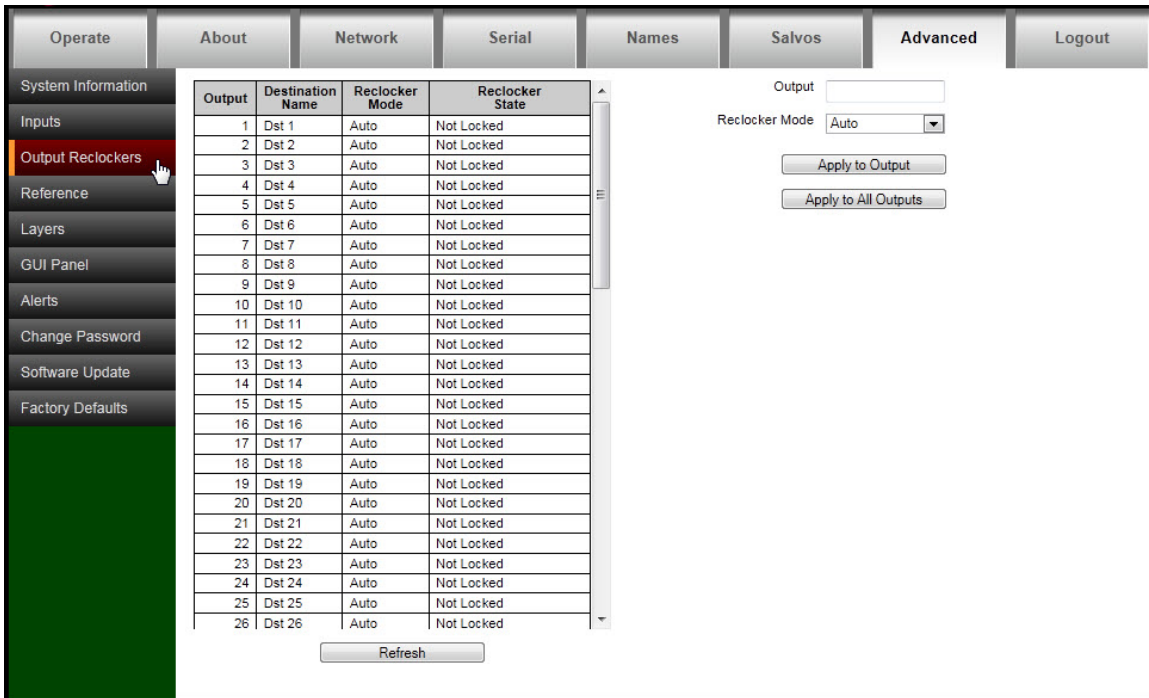

This screen will report the reclocker status and allow you to set the reclocker mode.

To set the reclocker mode of a single output, enter the output number, select the reclocker mode from the dropdown list and press “Apply to Output”.

To set the reclocker mode of all outputs, select the reclocker mode from the dropdown list and press “Apply to All Outputs”.

There are five states for the Reclocking Mode;

- Auto- Factory recommended mode
- Bypass
- HD (1.5G)
- SD
- 3G

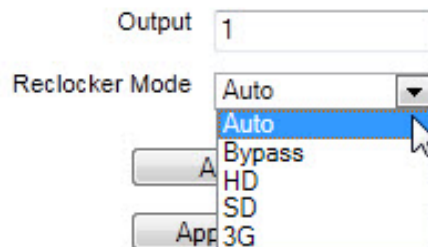

Output	Destination Name	Reclocker Mode	Reclocker State
1	Dst 1	Auto	Not Locked
2	Dst 2	Auto	Not Locked
3	Dst 3	Auto	Not Locked
4	Dst 4	Auto	Not Locked

The "Reclocker State" column indicates if the output reclockers are locked. When locked it will specify if it is SD, HD, or 3G.

---

***Warning!***

---

*Changes to this screen could effect operation of the routing switcher.*

## Reference Settings

This screen is for reporting status and setting the video reference input parameters allowing the video to switch at the correct point for “seamless” switching per SMPTE RP-168. If no reference signal is available or the “Redundant References” box is not checked, the routing switcher will switch at a random point rather than during the correct line (vertical interval) of the SDI input signal.

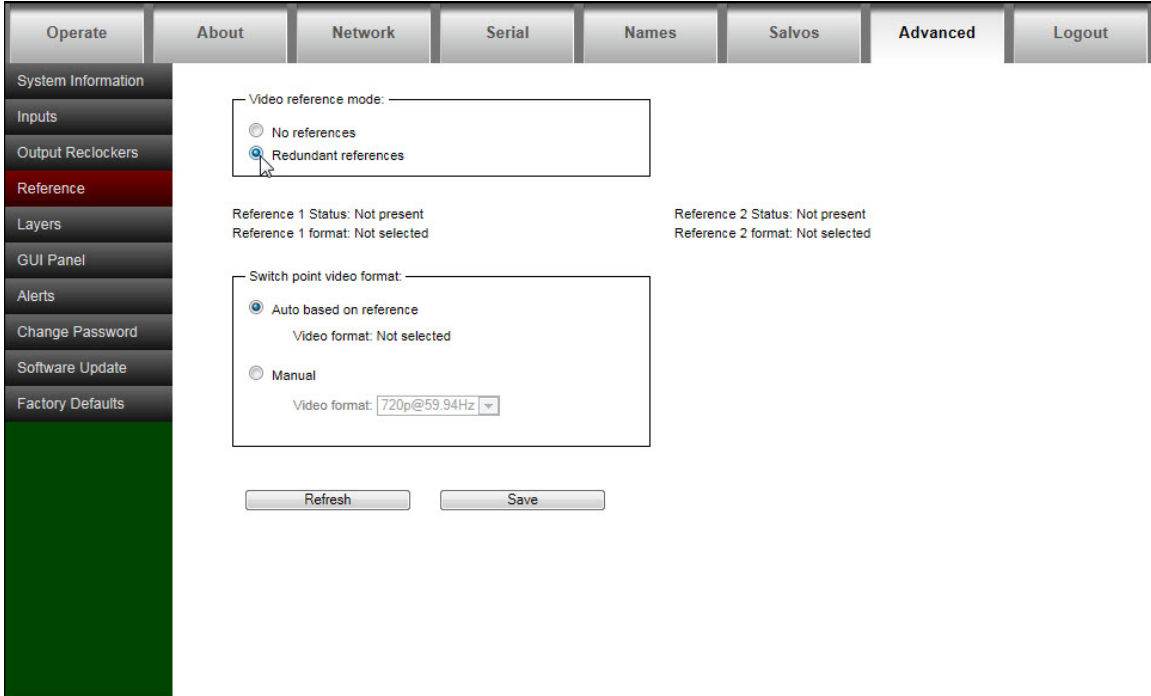

Selecting “Auto based on reference”, the reference input will automatically be detected and the routing switcher will switch based on the signal type applied to the reference input.

Selecting “Manual” allows you to manually select the video format of the signals passing through the routing switcher.

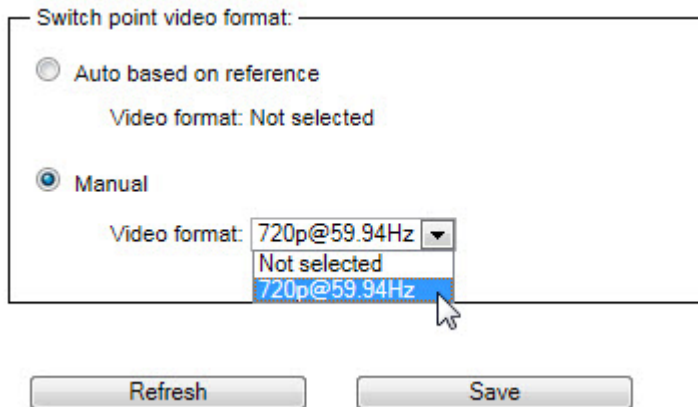

## Reference Formats

Video Reference	Supported video formats	Comments
NTSC (59.94Hz)	<b>SD@59.94Hz</b> 1080i@59.94Hz 720p@59.94Hz 1080p@59.94Hz	SD-SDI at 59.94Hz frame rate per SMPTE 259M-C (270Mbps) HD-SDI @1080i5994 HD-SDI @720p5994 3G-SDI @1080p5994
PAL (50 Hz)	<b>SD@50Hz</b> 1080i@50Hz 720p@50Hz 1080p@50Hz	SD-SDI at 50Hz frame rate per SMPTE 259M-C (270Mbps) HD-SDI @1080i50 HD-SDI @ 720p50 3G-SDI @1080p50
1080i@59.94Hz (Tri-Level Sync)	SD@59.94Hz <b>1080i@59.94Hz</b> 720p@59.94Hz 1080p@59.94Hz	SD-SDI at 59.94Hz frame rate per SMPTE 259M-C (270Mbps) HD-SDI @1080i5994 HD-SDI @720p5994 3G-SDI @1080p5994
1080i@50Hz (Tri-Level Sync)	SD@50Hz <b>1080i@50Hz</b> 720p@50Hz 1080p@50Hz	SD-SDI at 50Hz frame rate per SMPTE 259M-C (270Mbps) HD-SDI @1080i50 HD-SDI @ 720p50 3G-SDI @1080p50
720p@59.94Hz (Tri-Level Sync)	<b>720p@59.94Hz</b> 1080p@59.94Hz	HD-SDI @ 720p5994 3G-SDI @1080p5994
720p@50Hz (Tri-Level Sync)	<b>720p@50Hz</b> 1080p@50Hz	HD-SDI @ 720p50 3G-SDI @1080p50
1080p@59.94Hz (Tri-Level Sync)	720p@59.94Hz <b>1080p@59.94Hz</b>	HD-SDI @ 720p5994 3G-SDI @1080p5994
1080p@50Hz (Tri-Level Sync)	720p@50Hz <b>1080p@50Hz</b>	HD-SDI @ 720p50 3G-SDI @1080p50

Note: In the table above, the default video format for each reference is marked in **bold**.

## Layers

The “Layers” screen is used for adding external devices (Layers) to the existing routing switcher.

Operate About Network Serial Names Salvos Advanced Logout

System Information  
Inputs  
Output Reclockers  
Reference  
Layers  
GUI Panel  
Alerts  
Change Password  
Software Update  
Factory Defaults

Dual Link Mode    Number of Inputs: 72    Number of Sources: 72  
Number of Outputs: 72    Number of Destinations: 72

Number of Internal Layers: 1  
Number of External Layers: 1    Apply

Layer Number	Internal/External	Audio/Video	External Layer Number	Control Type	IP Address
1	Internal	Video			
2	External	Audio	1	Ethernet	192.168.6.91

Refresh    Save

The “refresh” button will re-read the current settings in the routing switcher.

Make any changes necessary and press “Save” to implement changes.

Enter the number of external layers you want to add and press “Apply”.

Number of Internal Layers: 1  
 Number of External Layers:

Select the correct layer type from the dropdown list.

Layer Number	Internal/ External	Audio/ Video	External Layer Number	Control Type	IP Address
1	Internal	Video			
2	External	<div style="border: 1px solid black; padding: 2px;">                     Video ▼                      Video                      Audio                 </div>	<input type="text" value="1"/>	Serial	

The “Video/Audio” selection determines whether the “A” or “V” button on the front panel will control the level.

---

**Note:**

To control external layers via serial the routing switcher must be set to “Master” mode (see “Serial” tab).

**When controlling an external routing switcher via the 9-pin serial connection, a “null modem” cable will probably be required. Check the pin-out on both devices to verify the cable needed.**

### Multi-Frame Systems

When controlling an external routing switcher via the 9-pin serial connection, a “null modem” cable will probably be required. Check the pin-out on both devices to verify the cable needed. The null-modem cable is not supplied. In the example below, the Aspen is connected to a Lassen routing switcher. In this case a null-model cable is needed. The null-modem cable is not supplied.

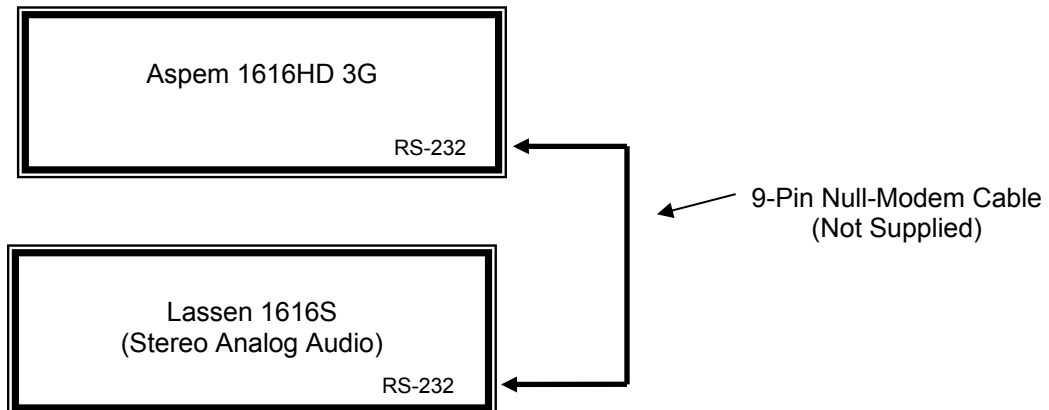

## Dual Link Mode

To set the routing switcher in the Dual Link mode, place a check in the “Dual Link Mode” box.

Dual Link Mode     
 Number of Inputs: 72     
 Number of Sources: 36  
 Number of Outputs: 72     
 Number of Destinations: 36

Number of Internal Layers: 1

Number of External Layers:      

When the Aspen 7272 is set in the dual link mode, it becomes a 36x36 with 2 BNC connectors per input and output.

BNC connectors for input and outputs in the dual link mode are as follows;

Input Button #s	Input Connector #s
1	1-2
2	3-4
3	5-6
4	7-8
5	9-10
6	11-12
7	13-14
8	15-16
9	17-18
10	19-20
11	21-22
12	23-24
13	25-26
14	27-28
15	29-30
16	31-32
17	33-34
18	35-36
19	37-38
20	39-40
21	41-42
22	43-44
23	45-46
24	47-48
25	49-50
26	51-52
27	53-54
28	55-56
29	57-58
30	59-60
31	61-62
32	63-64
33	65-66
34	67-68
35	69-70
36	71-72



Output Button #s	Output Connector #s
1	1-2
2	3-4
3	5-6
4	7-8
5	9-10
6	11-12
7	13-14
8	15-16
9	17-18
10	19-20
11	21-22
12	23-24
13	25-26
14	27-28
15	29-30
16	31-32
17	33-34
18	35-36
19	37-38
20	39-40
21	41-42
22	43-44
23	45-46
24	47-48
25	49-50
26	51-52
27	53-54
28	55-56
29	57-58
30	59-60
31	61-62
32	63-64
33	65-66
34	67-68
35	69-70
36	71-72

## GUI Panel

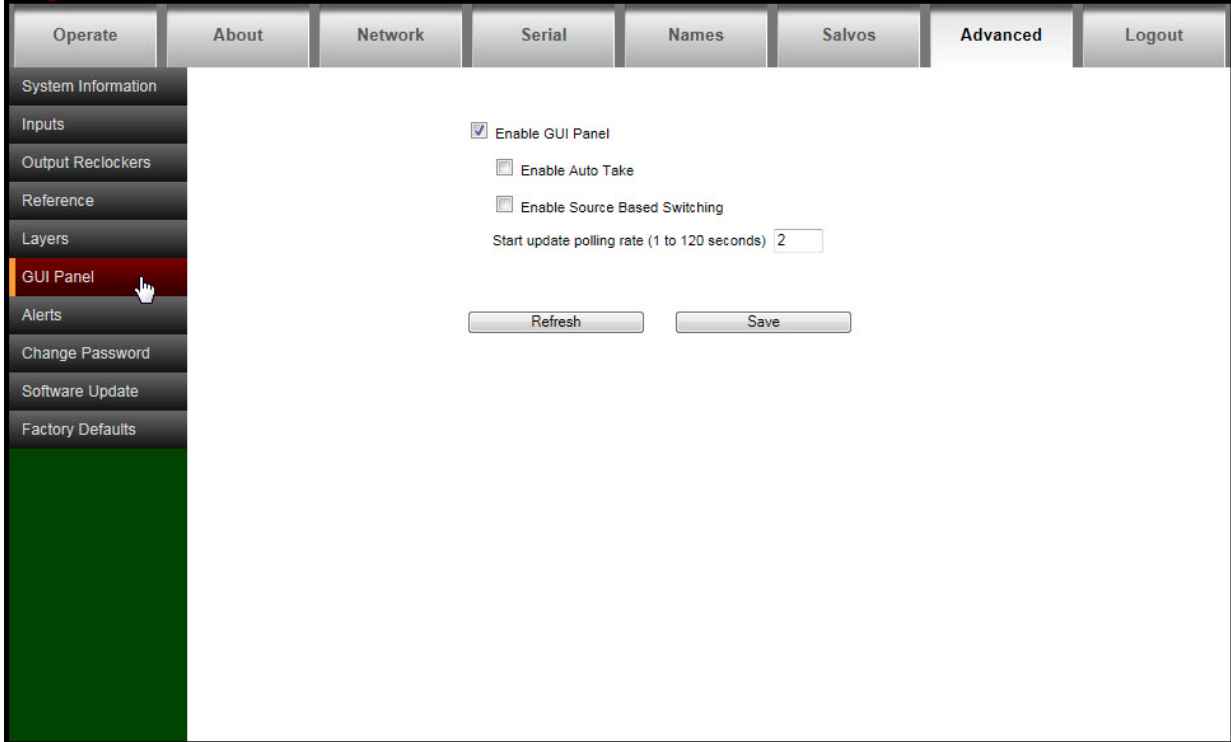

The GUI Panel is the switching panel that appears when the “Operate” tab is selected (see operation details in the next chapter).

The GUI switching panel can be enabled or disabled by placing a check in the box or not. Status polling time can also be set on this page.

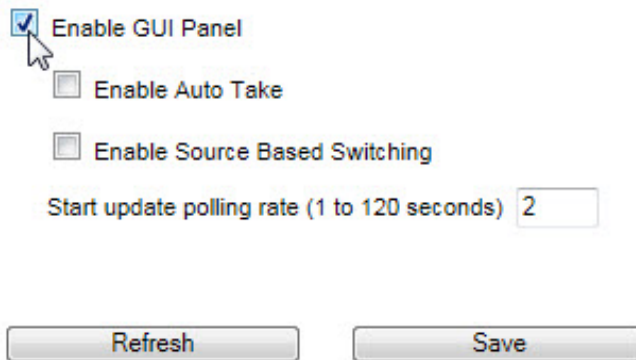

The GUI switching panel can be set for “Auto Take” mode. In the “Auto Take” mode, the routing switcher switches as soon a destination and source are selected (or a source and destination are selected if “Enable Source Based Switching” is selected (see below).

Enable GUI Panel

Enable Auto Take

Enable Source Based Switching

Start update polling rate (1 to 120 seconds)

Source based switching allows for a source to be selected first followed by selecting a destination. The factory default setting is the destination is selected first followed by selecting a source (box unchecked).

Enable GUI Panel

Enable Auto Take

Enable Source Based Switching

Start update polling rate (1 to 120 seconds)

## Alerts

The front panel has 3 LEDs labeled PS 1, PS 2, and Alarm.

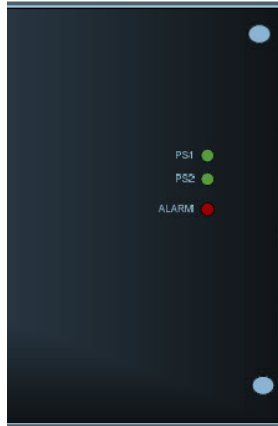

The PS 1 and PS 2 LEDs are green when power is present and off when not present.

The RED Alarm LED has 4 states;

Off

On

Slow Blink- 2 seconds on and 2 seconds off.

Fast Blink- 1/2 second on and 1/2 second off.

In normal operation, the alarm LED will be off if no error conditions are present. If there is an error condition, the LED will be on or blinking. See the troubleshooting section of this manual for a definition of error conditions.

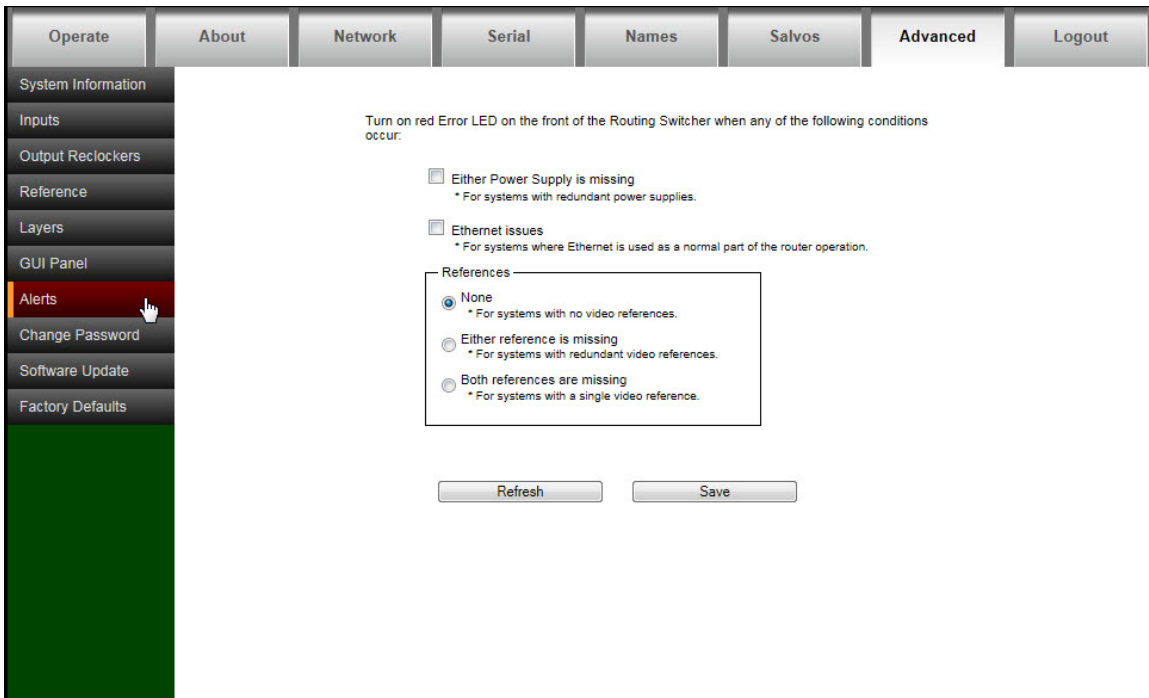



---

### Note:

If you do not have redundant power supplies, make sure the “Either Power Supply is Missing” box is not checked

## Changing Password

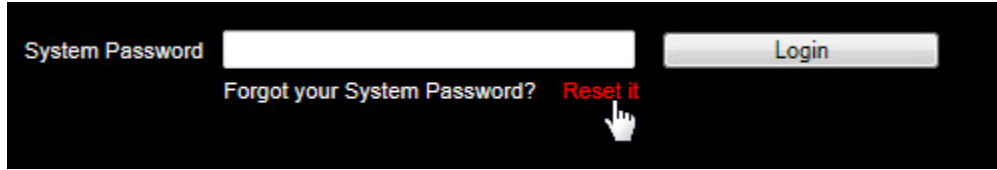
To change the password, or if you forgot your password, select “reset it” from the login screen.



Enter the new password, serial number of the unit and press “Save”.

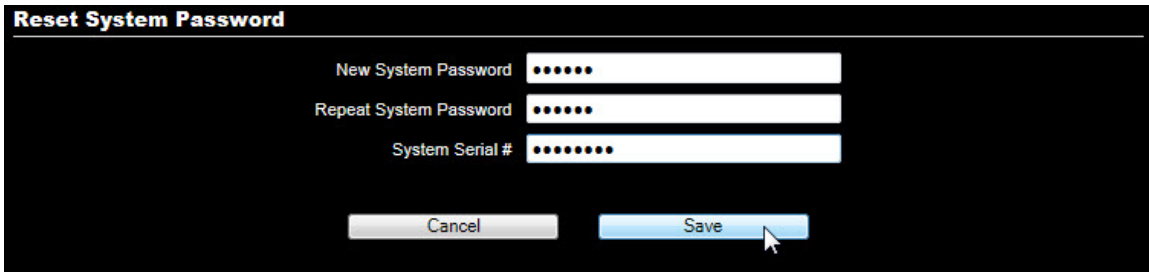

The password can also be changed from the “Advanced” tab (without entering the serial number).

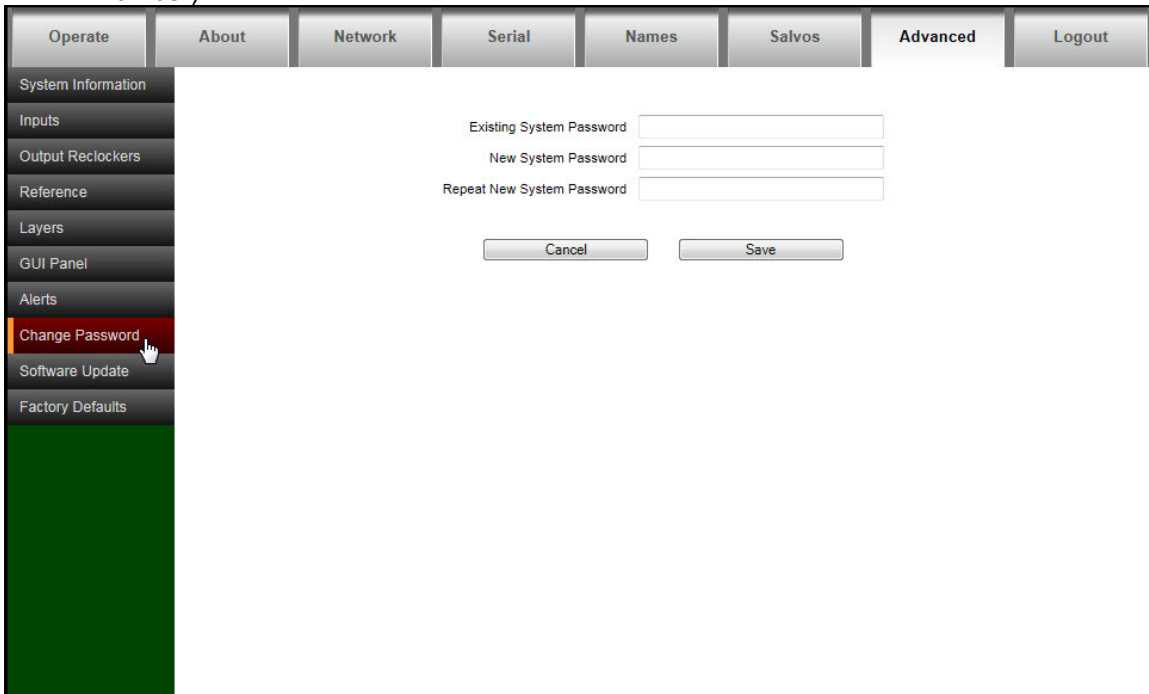

## Software Updates

From time to time software upgrades may be available from Sierra Video. Check our web site [sierravideo.com](http://sierravideo.com) for available downloads, or contact the factory.

Place the software update file on your computer and select browse to locate the file.

Press “Update Software” and progress status will display.

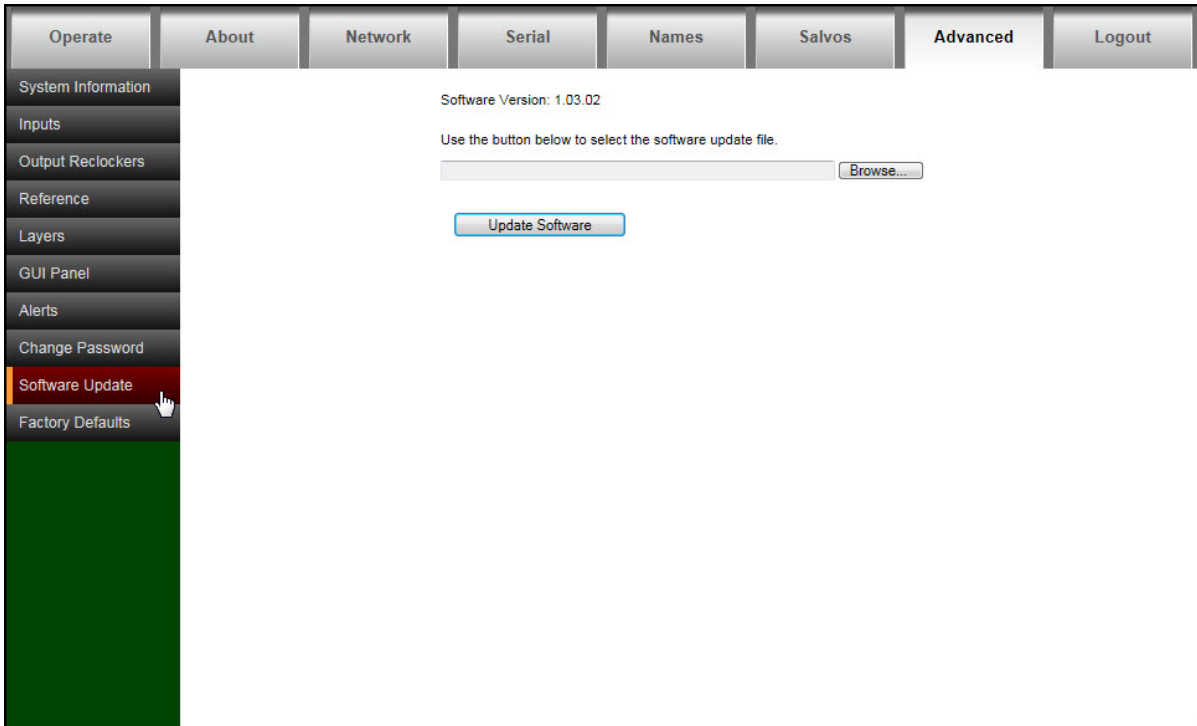

---

**Note:**

*The routing switcher will reset to complete the update.*

## Factory Defaults

This screen allows you to reset the routing switcher to the factory default settings. All routing switcher parameters are reset including the IP address.

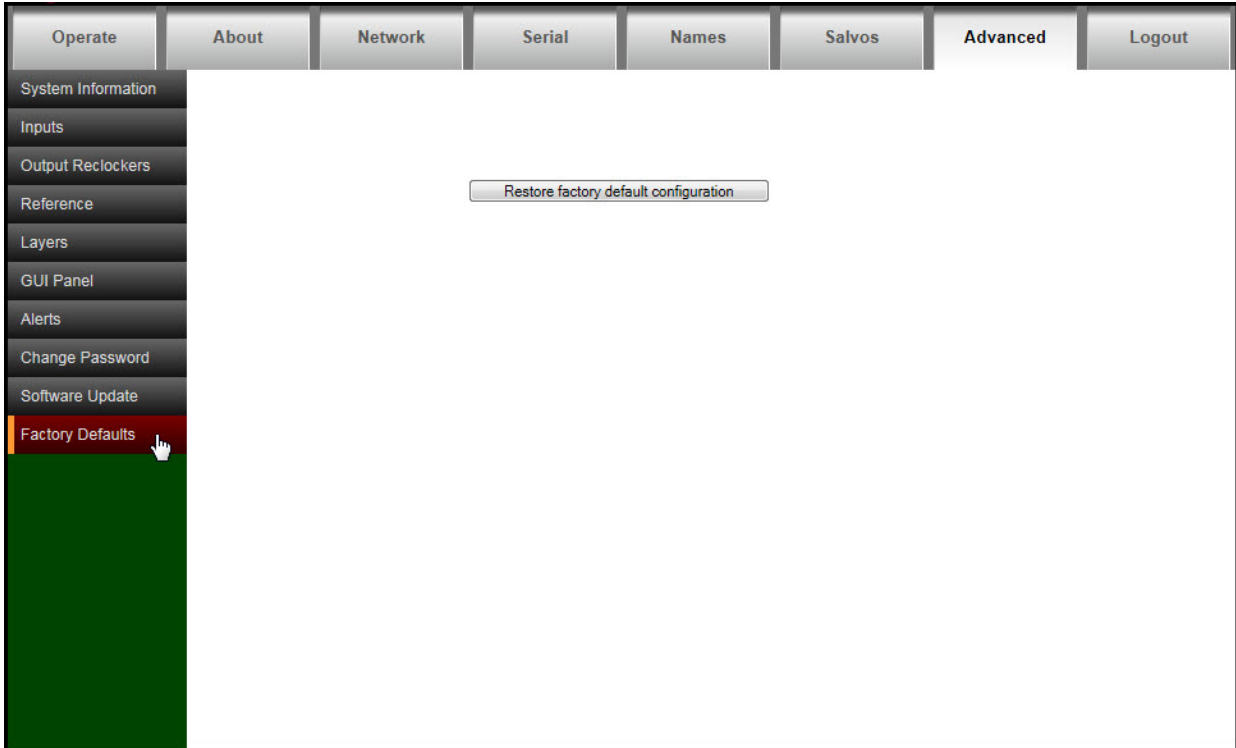

---

**CAUTION!**

---

*If you restore factory defaults, you will lose all configuration changes that you have made.*





# Operation

## Introduction

The purpose of a routing switcher is to switch any of the inputs (sources) to any of the outputs (destinations). Any input can be connected to any or all outputs but each output can only be connected to a single input. Control remains the most important component of your new system. The web page control panel empowers full control of the routing switcher. External control is also available via the Ethernet or serial port.

## Web Page

The Aspen family of routing switchers can be switched using the built-in web pages.

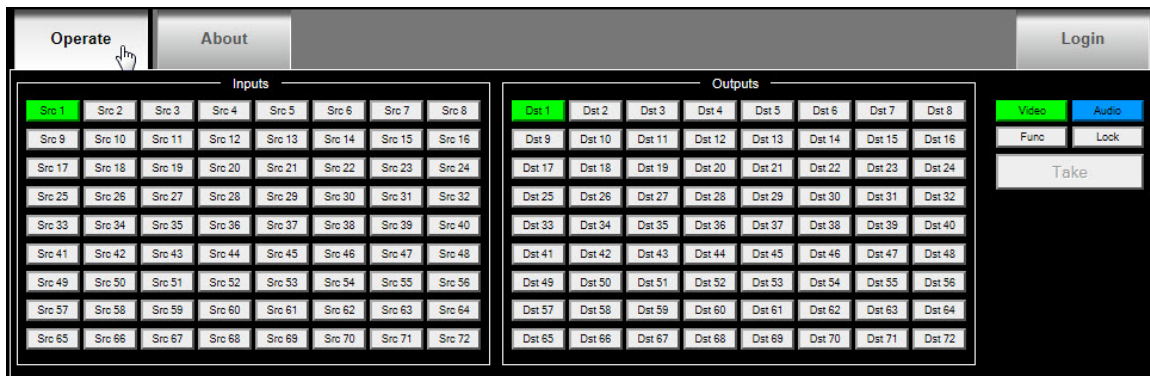

---

### Note:

*If audio is not present, the "Audio" button will be "greyed out".*

### Button Colors

- Take button will be blinking RED when enabled. Otherwise, it will be off.
- The FUNC button will be YELLOW in base operation.
- The LOCK button will be RED when the panel is locked. Otherwise, it will be off.
- The V (video levels) button will be GREEN when selected. Otherwise, it will be off.
- The A (audio levels) button will be BLUE when selected. Otherwise, it will be off.

## Switching the Routing switcher

### V and A Buttons

V (Video levels) button will enable the video level(s) to switch.

A (Audio levels) button will enable the Audio level(s) to switch.

In normal operation with at least one audio level configured:

- The V button will be on by default.  
The A button will be on by default.
- The V and A buttons will toggle on/off when pressed.

In normal operation with no audio level configured:

- The V button will remain on and will not respond to any selection of this button.
- The A button will remain off and will not respond to any selection of this button.

### Destination based Switching

1. Select an output
2. Select (enable level) to be switched by toggling the "A" and "V" button.- see above
3. Select an input (In auto take mode, the switch will occur immediately.)
4. If auto take mode is not enabled the "Take" button will blink RED- press take to initiate the switch.

### Break-away Switching

After selecting an output the "A" and "V" buttons may light indicating that both audio and video are preset to switch. Pressing the "A" or "V" button toggles the button on and off. On= enabled, Off= disabled. If video is only to be switched, press the "A" button turning it off so that only the video will switch.

---

**Note:**

---

*If audio is not present, the "Audio" button will be "greyed out".*

### Destination based Status

When an output is selected, the input currently connected to that output will light. When video and audio(if available) are routed from the same source then only that source button lamp will be lit.

Selected output button will be GREEN.

Input button colors:

CYAN to indicate video and audio.

GREEN to indicate video only.

BLUE to indicate audio only.

When a crosspoint switch is initiated from a point of control other than the local pushbutton interface, AND it involves the currently selected destination, THEN the source button tallies will be updated automatically.

## Source based Switching

1. Select an input
2. Select (enable level) to be switched by toggling the “A” and “V” button.
3. Select an output (. In auto take mode, the switch will occur immediately)
4. If auto take mode is not enabled the “Take” button will blink RED- press take to initiate the switch, or you can select additional outputs to preset takes for multiple outputs to the same selected source. In the latter case all selected outputs will be switched to the selected source when take is pressed.

## Source based Status

When an input is selected, the output(s) currently connected to that input will light.

Selected input button will be GREEN.

Output button colors:  
 CYAN to indicate video and audio.  
 GREEN to indicate video only.  
 BLUE to indicate audio only.

## Salvo

Salvos are programmed via the web page (see the Salvo Setup Section).

To fire a Salvo;

- Select the FUNC button. The button turns YELLOW
- Select the SALVO button. This button will illuminate BLUE.
- Buttons One (1) to Thirty-Two (32) in the INPUT section illuminate BLUE to indicate the registers available for choice. Only buttons that are stored as a salvo registers are illuminated.
- Select any of the illuminated buttons. The selected button will blink CYAN.
- The TAKE button begins to blink red
- Select TAKE
  - The salvo is executed
  - The FUNC button turns off
  - The front panel returns to normal operation mode

## Control via 9-pin Connectors

The 9-pin connector allows you to control the routing switcher via an external computer master router, or other controlling device. The serial port can be changed internally for RS422 configuration (RS232 @ 9600 baud is factory configuration).

The routing switcher has one port labeled on the back panel as "RS232/422" (refer also to the illustrations of back panel shown in *Chapter 1*):

Connection to the RS-232/422 port is made using a standard 9 pin (pin to pin) cable.

Pin	RS-232	RS-422
1	Not Used	Ground
2	Transmit	Transmit (-)
3	Receive	Receive (+)
4	Not used	Not used
5	Ground	Not used
6	Not used	Not used
7	Not used	Transmit (+)
8	Not Used	Receive (-)
9	Not Used	Ground

---

### **NOTE:**

---

*To convert the 9-pin connector to an RS422 serial port see the serial setup section.*

## Control via Ethernet

The crosspoints in the routing switcher may be controlled via Ethernet using the Host Protocol. To control the routing switcher, establish a TCP/IP connection to the IP address of the routing switcher using port number 10001. A communications program such as telnet can be used to establish this connection. Once the connection is established, sending the command **\*\*!!** should cause the routing switcher to return **\*\* OK !!**. This connection supports the entire Sierra Video Host protocol command set supported by this model.

# HOST Protocol

## Introduction

This section of this manual contains the most common Host Protocol commands. For a more detailed list of Protocol commands contact the Sierra Video factory.

The protocol uses the 7-bit ASCII character set. The protocol is compact, with few characters required to cause switch changes to occur. It is also human-readable and thus easy to understand and use.

All input, output, and level numbers begin at number 1, not 0.

---

**Note:**

---

*When writing commands for a "third party" controller, pay careful attention to the levels of control.*

Commands are sent to a routing switcher in a group called a command string.

A command string consists of a leader string of asterisk characters (\*\*), zero, or more commands, and a trailer string of exclamation marks (!).

When a command string is received, it is not acted upon until the final trailer character (!) of the command string is received.

Within the command string, certain ASCII characters may be present and are ignored: any ASCII character whose code is *less than* the SPACE character (includes all control characters and the SPACE character) and the DEL (ASCII 7F) character. Alphabetic characters within the command string may be in either upper-case or lower-case letters. The routing switcher always *sends* upper case characters, except for character strings such as input, output, and level names, which may have lower case characters in them.

When sending commands *to* the routing switcher, SPACE characters are optional. SPACES may also appear in character strings, such as input, output, and level names.

Certain commands have character strings that appear as arguments and use a ~ (tilda) character to delimit the character strings. The use of the tilda varies and will be defined in the individual commands.

After the command string has been executed, the routing switcher sends the following to the host.

**\*\*OK!!**

This indicates that the command has executed successfully.

The simplest possible command string would be: \*\*!! which consists of the leader and trailer characters. This command string would generate the response:

\*\* OK !!

This can be useful for verifying that the communication to the routing switcher is operational.

If an error occurs within a command string, the remainder of the command string is ignored and the routing switcher returns the string " ERROR ", followed by *an optional descriptive string* followed by a string of trailer characters, to the host.

The simplest error response is one with no optional descriptive string. For example, this command string:

\*\* XXX !!

might generate this response from the routing switcher:

\*\* ERROR Syntax: No Number:XX !!

## Command Summary

The following is the set of commands available for sending to the routing switcher.

Syntax	Example	Description
I	I	Capabilities Inquiry
Q	Q	Model Name and Software Version Inquiry
L	L	Routing Switcher Size and Level Names Inquiry
N	N	Source Status
O	O5	Output Status inquiry
S	S	Status inquiry
U {0 1}	U0	Update request on/off
V out,in,in...	V3,1,2,2	Connect levels
X out,in,lvl	X12,9,2	Connect crosspoint
Y out,in	Y1,7	Connect AFV
T {1-16}	T1	Trigger a Salvo Connect sequence
G	G SRC_NAMES,1,0~	The command "G" is used to query or modify a routing switcher configuration parameter or parameters.

### ***"RESET": Routing switcher Reset***

When the routing switcher is powered up, the following will be sent on the serial port.

\*\*RESET!!

### ***"I": Capabilities Inquiry***

The command "I" requests that command capability information be returned to the host. The information is sent as a string of characters. The first characters are a space followed by "I", the next characters are the letters of the commands that are implemented and available in this routing switcher, and the last character is "~" (tilde). Do not count on the characters being in any specific order. Search all characters for a particular one.

For example, the command:

\*\*I!!

might return the following string:

\*\* ILSX~ OK !!

indicating that the routing switcher supports the **I**, **L**, **S**, and **X** commands from the host.

**“Q”: Model Name and Software Version Inquiry**

The command "Q" requests that the routing switcher model name and software version number string be returned to the host. The information is sent as a string of characters. The first characters are a space followed by "Q", the next characters are the routing switcher model name, terminated by a "~" (tilde). Following this are the characters of the software version number string, again terminated by a "~" (tilde).

For example, the command:

```
**Q!!
```

might return the following string:

```
** QSmall~V2.1~ OK !!<CR>
```

indicating that the routing switcher model name is "Small" and the software version number is "V2.1".

**“L”: Routing Switcher Size and Level Names Inquiry**

The command "L" requests that routing switcher size and level name information be returned to the host. The information is sent as a string of characters. The first characters are a space followed by "L", some optional values described below, then the number of outputs, a comma, the number of levels, a comma, the number of inputs, a comma, and then the level names, each terminated by a "~" (tilde), and the last followed by two tildes.

For example, the command:

```
**L!!
```

might return the following string:

```
** L64,3,32,VIDEO~AudioL~AudioR~~ OK !!
```

indicating that the routing switcher has 64 outputs, 3 levels, and 32 inputs, and the levels are named "VIDEO", "Audio L", and "Audio R".

**“N”: Source Status Inquiry**

The command "N" requests that status information for a single source be returned to the host. The status information is sent as one or more "Y" and/or "X" commands.

For example, the command:

```
**N4!!
```

to a router might have the following commands as its response:

```
** X12,4,1 X12,4,2 X12,4,3 X13,4,4 Y23,4 !!
```

showing that source 4 connects to

- destination 12 on levels 1-3,
- destination 13 on level 4, and
- destination 23 on all levels.



**“O”: Output Status Inquiry**

The command "o" requests that the status information for a single output be returned to the host. The status information is sent as a "Y" command or a "V" command or as a sequence of L "X" commands, where L=number of levels.

For example, the command:

```
**O5!!
```

to a 3-level routing switcher might have the following three commands as its response:

```
** X65,23,1 X5,-,2 X5,0,3 !!
```

Note the dash, indicating that on level 2, output 65 is not connected to an input. Also note the 0, indicating that the connection on level 3 is either unknown or that output 65 doesn't exist or isn't mapped on level 3.

Or, a 3-level routing switcher might have the following single command as its response:

```
** V65,23,-,0 !!
```

which has the same information as the three X commands in the previous example.

If the routing switcher has only one level, or if all levels are connected the same, the routing switcher might instead use the Y command. For example:

```
** Y65,23 !!
```

**“S”: Status Inquiry**

Use command "S" to request that status information be returned to the host. The status information is sent as a series of strings.

For example, the command:

```
**S!!
```

might have the following two strings at the beginning of its response:

```
**V1, 12!!
```

```
**V2, 2!!
```

This indicates that output 1 is connected to input 12 on level 1, and that output 2 is connected to input 2 on level 1.

**“U”: Update Request on/off**

The command "u" turns on or off the automatic sending of output change reports. The current mode can be queried with the command \*\* U !!. To change the setting, the command letter must be followed by either a number 0,1 or 2 to specify the new automatic change report state, as follows:

0: Automatic output change reporting is turned off.

1: Automatic output change reporting is turned on. Crosspoint change commands do not immediately report changed status, but instead, the report comes up to a few seconds after the crosspoint change command is received. The Aspen will send X commands when crosspoints change.

2: Automatic output change reporting is turned on, and crosspoint change commands immediately report changed status as part of the response to the command. The Aspen will send X commands when crosspoints change.

3: Same as mode 1 except the Aspen will send V commands when crosspoints change.

4: Same as mode 2 except the Aspen will send V commands when crosspoints change.

Output change reports are automatic messages sent to the host whenever an output is crosspoint status (i.e. connected source) is changed.

For example, the command:

```
**U1!!
```

turns on automatic output change reporting. When a crosspoint is changed, the "X" command will be sent to report the change. For example:

```
** X5,12,2 !!
```

indicating that output 5 is now connected to input 17 on level 1, to input 12 on level 2, and does not exist or is not available on level 3.

To turn off output change reporting, use the command:

```
**U0!!
```

For example, suppose the routing switcher sends the following crosspoint connect commands in a single command sequence:

```
** Y1,18!!
```

If U1 is in effect, the response to this command will be:

```
** OK !!
```

and then sometime later, the crosspoint change report will be sent

```
** X1,18 !!
```

### **"V": Connect Levels**

The command "v" is used to request that a connection be made. It must be followed by an output number, a comma, and a comma-separated list of input numbers, one for each level. Fewer than the number of levels in the routing switcher may be specified if desired, and the remaining levels will be left unchanged.

For example, the command:

```
**V12,7,8,9!!
```

says that connections are to be made to output 12: from input 7 on level 1, input 8 on level 2, and input 9 on level 3.

An input number of 0 means the output connection is to be left *unchanged*.

An input number of \*-\* (dash) means the output is to be *disconnected*. If the routing switcher does not support disconnected outputs, the output connection will be left unchanged.

### **"X": Connect Crosspoint**

Use command X to request that a connection be made. It must be followed by an output number, a comma, an input number, a comma, and a level number. For example:

```
**X8, 3, 2!!
```

This string says that a connection is to be made between output 8 and input 3 on level 2. If the level number is specified as "0", this means that the connection is to be made on all levels (AFV).

**“Y”: Connect AFV**

Use command Y to request that a connection be made on all levels (AFV). It must be followed by an output number, a comma, and an input number.

For example, the command:

```
**Y2, 8!!
```

This string says that input 8 is to be connected to output 2 on all levels.

**“T”: Trigger a Salvo**

The command "T" is used to trigger a previously set up *salvo*. It must be followed by a register number from 1 to 32 giving the *register* to be triggered.

For example, the command:

```
** T2 !!
```

says to trigger salvo register 2.

If a salvo is triggered and it fails for some reason, the salvo trigger operation is aborted, and an error is reported:

For example:

```
"ERROR Salvo Has Locked Xpts".
```

**“G” Command**

Details of the “G” command can be found on our website or by contacting the factory.

## ***Commonly Used Switching Commands***

This section contains the most commonly used switching commands. These commands are explained in detail in the proceeding.

### **“Y” Command- All Levels**

The “Y” command switches all levels (i.e. video and audio).

For example;

**\*\*Y2,8!!**

This requests that input 8 be connected to output 2 on all levels.

### **“X” Command- Specify Levels**

Using the “X” command requires that a level is specified.

For example;

**\*\*X8, 3, 2!!**

This requests that a connection is to be made between output 8 and input 3 on level 2. If a level number of “0” is used, all levels are switched.

### **“V” Command- Connect Levels**

The “V” command is followed by an output number, a comma, and an input number for each level, up to the number of levels on the routing switcher.

For example;

**\*\*V12, 7, 8, 9!!**

This requests that connections are to be made to output 12 from input 7 on level 1, input 8 on level 2, and input 9 on level 3.

# Troubleshooting

## Front Panel Error Indications

### Alarm LED Error Conditions

For these errors list below, the error LED will be on or blinking if any one of these errors is present. The error LED will be off only if none of these error conditions are present.

### Blinking

This is a serious problem with the router where it cannot operate properly.

To resolve the issue:

1. Connect to the unit via your web browser to determine the issue.
2. If you cannot connect via your web browser, power cycle the unit.
3. If you still cannot connect via your web browser, reset the unit to factory defaults.
4. If you still cannot connect via your web browser and the LED is still blinking, contact customer service.

### Other Errors

For these errors, the error LED will be on (not blinking) if any one of these errors is present.

The conditions that the software can look for are listed below.

### Power Supply Status

There are two options for Power Supply status (settable on the web page):

1. Turn on the error LED if either power supply is missing
2. Ignore power supply status

### Reference Status

There are three options for Reference status (settable on the web page):

1. Turn on the error LED if either reference is missing
2. Turn on the error LED if both references are missing
3. Ignore references

### Network Error

There are two options (settable on the web page):

1. Turn on the error LED if there is a network error
2. Ignore network errors

The conditions that will trigger a network error are:

- No network connected
- Invalid IP address in the router

**Fan Status**

The software will turn on the error LED if the fan stops.

**Temperature Status**

The software will turn on the error LED if any internal temperature sensor within the unit goes above a safe operating temperature.

---

**NOTES:**

---

*If the output signal is disturbed or interrupted by electromagnetic interference, the signal should return and stabilize when the interference ends. If not, disconnect the AC power cord and reconnect it again to reset the switcher.*

*If the following recommended actions still do not result in satisfactory operation, please consult your Sierra Video Dealer.*

**Power and Indicators**

Problem	Remedy
No power	<ul style="list-style-type: none"><li data-bbox="548 800 1395 890">▪ Confirm that power connections are secured at the switcher and at the receptacle. Make sure the receptacle is active, with the proper mains voltage.</li></ul>

### **Video Signal**

<b>Problem</b>	<b>Remedy</b>
<p>No video at the output device, regardless of input selected.</p>	<ul style="list-style-type: none"> <li>▪ Confirm that your source and destination devices are powered on and connected properly. Video signals connected to the routing switcher should have a video supported format supported by your video monitor or other destination connected to the routing switcher output.</li> <li>▪ Confirm that any other switchers in the signal path have the proper input and/or output selected.</li> <li>▪ Use a Video Tester to test the video path leading to/from your Routing Switcher.</li> </ul>
<p>. Routing switcher takes are not “seamless” switching</p>	<ul style="list-style-type: none"> <li>▪ Verify that the video reference is terminated with a 75 ohm impedance. Verify that the video reference is only terminated one time, and that the termination is at the last piece of equipment in the video reference loop thru chain.</li> <li>▪ Confirm that the connecting cables are of high quality and not damaged. Ensure you have selected the correct, supported SDI format for the video reference you have connected to the routing switcher.</li> <li>▪ Check that your video signal matches the SDI format you have selected to provide “seamless” switching with the video reference format you have connected to the routing switcher.                             <ul style="list-style-type: none"> <li>▪ Check that the video reference is the format you have selected for “seamless” switching.</li> </ul> </li> <li>▪ Verify that “no references” is NOT checked on the advanced, reference page of the webpage.</li> <li>▪ Check that the SDI sources connected to the routing switcher inputs are vertically locked to the video reference connected to the routing switcher.</li> </ul>

### **Control**

Problem	Remedy
<p>No control of Routing Switcher from PC software</p>	<ul style="list-style-type: none"> <li>▪ Confirm the correct wiring of the connecting cable. Be sure to use a standard one to one 9 pin serial cable.</li> <li>▪ Confirm that the baud rate of your computer COM port is set to the same as that of your Routing Switcher (9600-Baud factory default). Confirm that the proper COM port is selected in the control software.</li> <li>▪ Use a terminal emulator program to send <b>***</b> commands and check for <b>**OK!!</b> response.                             <ul style="list-style-type: none"> <li>▪ If you do not receive <b>**OK!!</b>, the problem is with the switcher.</li> </ul> </li> </ul>

### **Switching Malfunctions**

Problem	Remedy
<p>The switcher succeeds in switching a number of sources then fails to switch one.</p>	<p>Malfunction in the particular source or cable assembly.</p> <p style="text-align: center;">NOTE:</p> <p>The most common failure mode in transferring the signal of an audio source is a break in the connecting wire.</p> <ul style="list-style-type: none"> <li>▪ Disconnect the source from a channel that is switching successfully and connect the suspect source to it. If the channel continues to switch successfully, then there is something wrong with the Routing Switcher or the suspect source was not connected properly. If it does not continue to switch successfully, then there is something wrong with the source or cable assembly.</li> </ul>

### **Technical Support**

Sierra Video has made every effort to insure that your unit has been fully tested and is configured to your order specifications. If problems arise that can not be resolved, please contact the Sierra Video technical support department.

Sierra Video factory- (530) 478-1000

Email- [service@sierravideo.com](mailto:service@sierravideo.com)



# Specifications

<b>Video</b>	
Data rates	19Mbps to 2.97 Gbps
Data types	SMPTE 259M-C, SMPTE 292, SMPTE 424M, DVB-ASI
Input cable equalization range (Belden 1694A)	3G, 0 – 155 meters HD, 0 – 200 meters SD, 0 – 400 meters
Input return loss	≥15db@ 1.485Gps, ≥10db@ 2.97Gbps
Output level	800 mV p-p +/- 10%
Output timing jitter	SMPTE 424M ≤ 2.0UI SMPTE 292 ≤ 1.0UI SMPTE 259M-C ≤ 0.2UI
Output alignment jitter	SMPTE 424M ≤ 0.3UI SMPTE 292 ≤ 0.2UI SMPTE 259M-C ≤ 0.2UI
Output return loss	≥15db@ 1.485Gps, ≥10db@ 2.97Gbps
<b>Mechanical</b>	
I/O connectors	75 Ohm BNC
Operating Temperature	0C – 40C (32F – 104F)
Dimensions	7.0 (178mm) x 19.0 (483mm) x 2.5 (64mm)
Weight	7.0 lbs (3.2 kg)
<b>Electrical</b>	
AC Input Range	100-240V, 50-60Hz
Power	55W
<b>Communication</b>	
Ethernet (1)	10/100 Base-T (RJ45)
Serial Port (1)	RS-232/422 (DB-9)



# Warranty

## **A. General**

Buyer assumes all responsibility for ascertaining the suitability of Sierra Video (hereinafter "SVS") products for Buyer's intended use. No product sold by SVS is designed or manufactured for use in any manner or under any conditions other than those described in SVS's instruction manuals and other printed material for each particular product. If any product is used or applied in a manner or under conditions not specifically authorized by such written materials or if any product is used by unqualified or improperly trained personnel, Buyer agrees that SVS shall have no liability of any kind arising from such use, and Buyer agrees to indemnify and hold SVS harmless from any claims of third parties arising from such use, and Buyer shall provide SVS with counsel of SVS's choice to defend against such claims.

## **B. Limited Warranty**

1. This limited warranty applies only to the original purchaser and is non-transferable. This limited warranty begins on the date of purchase and will be in effect for seven (7) years for new equipment and for three (3) years for "Factory Refurbished" equipment. Power Supplies and fans are warranted for three (3) years from the date of purchase for new equipment and two (2) years for "Factory Refurbished" units, from the date of purchase.

Buyer must obtain a Return Material Authorization ("RMA") number from SVS prior to returning a product for repair. If, in SVS' sole discretion, the product is found to be defective during the term of this warranty, SVS will at its option: (a) provide free replacement parts, and/or (b) repair the unit at an SVS facility. During the warranty period, SVS will make every reasonable effort to support critical emergencies by supplying no-cost loan equipment while the defective unit is being repaired. SVS will provide replacement parts and/or factory service at no charge. Buyer bears the cost of shipping products returned to SVS under this warranty. SVS will bear the cost of shipping repaired products or replacement parts to the Buyer.

This limited warranty shall not apply to any of SVS's goods which have been altered or which have been subjected to misuse, mishandling, improper storage or negligence. The aforementioned provisions do not extend the original warranty period of any goods which have been replaced by SVS. This limited warranty shall not apply to any goods not of SVS's manufacture, Buyer to be entitled only to the warranty set forth in the original manufacturer's limited warranty.

THIS LIMITED WARRANTY IS EXPRESSED IN LIEU OF ALL OTHER WARRANTIES, EXPRESS, IMPLIED OR STATUTORY, INCLUDING WITHOUT LIMITATION THE IMPLIED WARRANTIES OF MERCHANTABILITY AND OF FITNESS FOR A PARTICULAR PURPOSE, AND ALL OTHER OBLIGATIONS OR LIABILITIES ON SVS'S PART.

SVS neither assumes nor authorizes any other person to assume for SVS any other liabilities in connection with the sale of products of its own manufacture.

2. SVS's liability hereunder on any claim of any kind, except as set forth herein for any loss, injury to person or property or damage, shall in no case exceed the price allocable to the goods which give rise to such claim.

3. In no event shall SVS be liable for any damages or injuries to person or property if any goods do not meet the above limited warranty, including, without limitation, incidental expenses or consequential or special damages, except as set forth in such limited warranty. The foregoing states the exclusive remedy of Buyer and the exclusive liability of SVS for any breach of the foregoing limited warranty.

### **C. Cancellation**

Except as provided in paragraph B immediately above, all sales are final, and Buyer may cancel this order or return products only upon written consent of SVS.

### **D. General**

In the event of a breach of any of the terms hereof, the non-breaching party shall be entitled to recover all of its costs, fees, and expenses, including, without limitation, reasonable attorney's fees, from the breach party incurred as a result of such breach, regardless of whether or not a suit is actually filed to enforce the terms hereof.

The provision hereof shall be governed by the laws of the State of California (excluding its choice of law provisions).

The headings are for convenience only and do not limit or amplify the terms and provisions hereof.

In case any one or more of the provisions set forth herein shall be held to be invalid, illegal, or unenforceable in any respect, the validity, legality, and enforceability of the remaining provisions contained herein shall not in any way be affected or impaired thereby.

No waiver, alteration, or modification of any of the provisions hereof shall be binding unless in writing and signed by an authorized Officer of SVS.

---

#### **NOTE:**

---

*All products returned to SVS for service must have prior approval. Return authorization requests may be obtained from your SVS dealer.*